

High-Current Measurement with Allegro Current Sensor IC and Ferromagnetic Core: Impact of Eddy Currents

By Yannick Vuillermet,
Allegro MicroSystems Europe Ltd

Introduction

The technique of measuring bus bar current with a surrounding ferromagnetic core is common knowledge. For high-current measurement above 200 A, Allegro recommends using a linear IC of the A136x family, such as the A1367, in conjunction with a magnetic core (Figure 1). This document focuses on alternating current (AC) effects on the current measurement. AC input currents tend to generate eddy currents in the magnetic core. These eddy currents alter the measured magnetic field and consequently decrease current measurement accuracy.

For more details about core design, refer to “Guidelines for Designing a Concentrator for High-Current Sensing Applications with an Allegro Hall-Effect Sensor IC” [1], available on the Allegro website.

Note that all results in this document come from electromagnetic simulations performed in Ansys Maxwell software.

Measurement Principle

Ideally, the magnetic field, H , in the air gap is perfectly proportional to the input current, I , in the bus bar or current-conducting wire. Thus, it is enough to measure this magnetic field with a linear magnetic field sensor and to characterize the coefficient between the input current and the magnetic field to measure this input current. This coefficient, S_C , is called the coupling factor or the core sensitivity.

However, this coupling factor is only constant over a limited range of current and frequency. Any change of this coefficient leads to input current measurement error. Typical accuracy requirements are in the range of a few percent of the measured current.

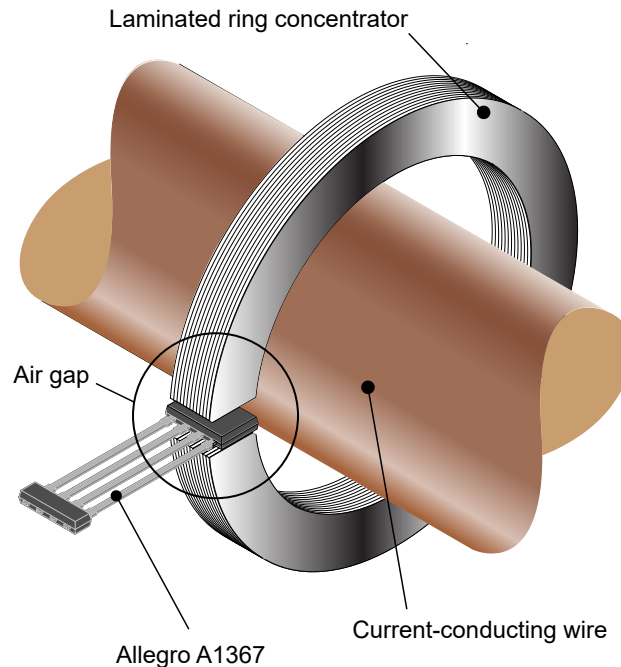

Figure 1: Typical high-current sensing system with magnetic core and Allegro A1367

[1] “Guidelines for Designing a Concentrator for High-Current Sensing Applications with an Allegro Hall-Effect Sensor IC”,
<https://www.allegromicro.com/en/Design-Center/Technical-Documents/Hall-Effect-Sensor-IC-Publications/Current-Sensor-Concentrator.aspx>.

Eddy Current Basics

Eddy currents are a direct effect of Lenz's law which states that the direction and magnitude of the current induced in a conductor by a varying magnetic field is such that it creates a magnetic field that opposes the change that produced it.

In an AC current sensor application using a ferromagnetic core, eddy currents are induced inside the core as a response of the tangential varying magnetic field. Figure 2 shows a YZ cross section that schematically represents the eddy currents in a bulk core. These eddy currents generate an induced magnetic field, H_{eddy} , opposite to the exciting magnetic field, H_{exc} . This is measured at the sensor level as a reduced core sensitivity, S_C , or otherwise said, a current measurement error.

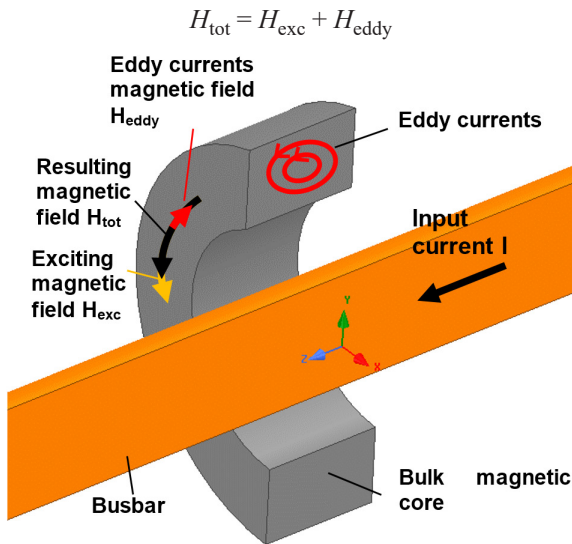

Figure 2: Schematic view of eddy currents in a bulk magnetic core

In order to reduce eddy currents, it is necessary to cut the current paths in the core. This is achieved by using a laminated core with thin sheets. These sheets must be electrically isolated from each other.

The lamination can be done in the Y direction by rolling or in the Z direction by stacking sheets (Figure 3). Eddy currents still flow, but with a reduced magnitude.

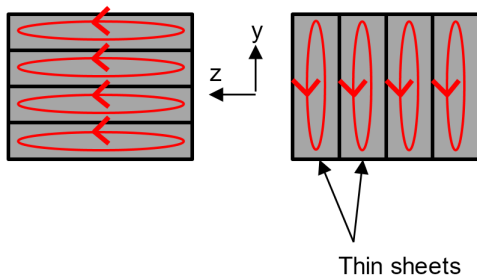

Figure 3: Laminated core and corresponding eddy currents: rolled (left) and stacked (right)

Typical Application Using Allegro A1367LKT Linear Sensor IC

A typical high-current application using an Allegro A1367LKT linear sensor IC is considered here. Maximum peak current in this application is 600 A. The geometry is as given in Figure 4. The core length along the Z axis is 6 mm. The core is made of ferromagnetic material such as grain-oriented silicon steel with typical magnetic characteristics as in Figure 5. Initial relative permeability is 10000 and magnetic polarization at saturation is 1.8 T. Note that for the sake of simplicity, magnetic hysteresis is not considered. The core electrical resistivity is $45 \mu\Omega/\text{cm}$.

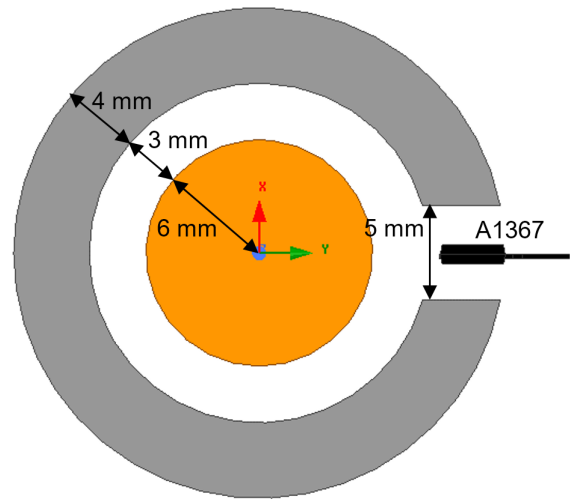

Figure 4: Core design

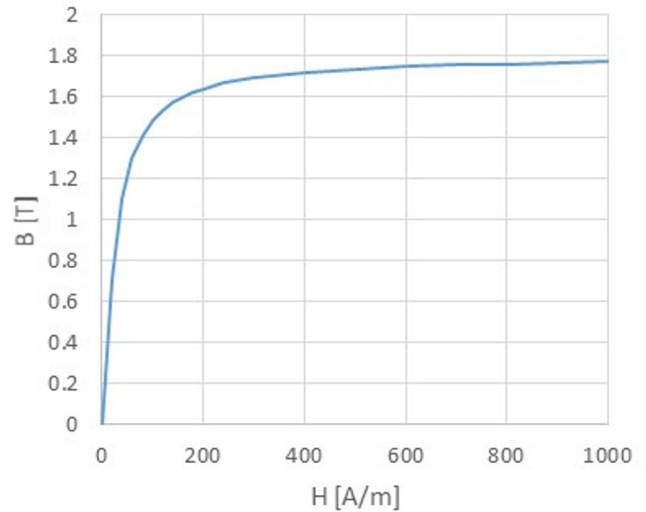

Figure 5: Core magnetic characteristics

The DC core sensitivity, S_C , is evaluated from 0 to 600 A. Figure 6 reports the expected measured field at the A1367 Hall plate location and the expected core sensitivity. The core magnetic sensitivity is constant up to the maximum current, as expected. The core sensitivity is around 2.36 G/A. In bipolar

mode, the A1367 uses a ± 2 V output span. Consequently, the IC sensitivity is ~ 1.4 mV/G, and the recommended A1367 part option would be A1367-LKTTN-2B-T. Figure 7 displays the core magnetization at maximum DC current; the magnetization does not reach saturation.

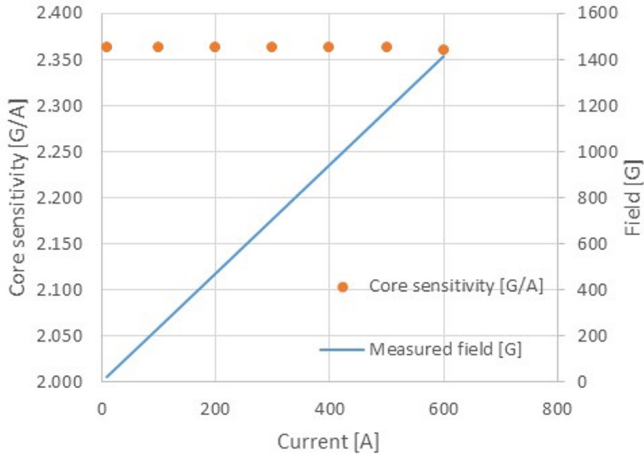

Figure 6: DC core magnetic performance

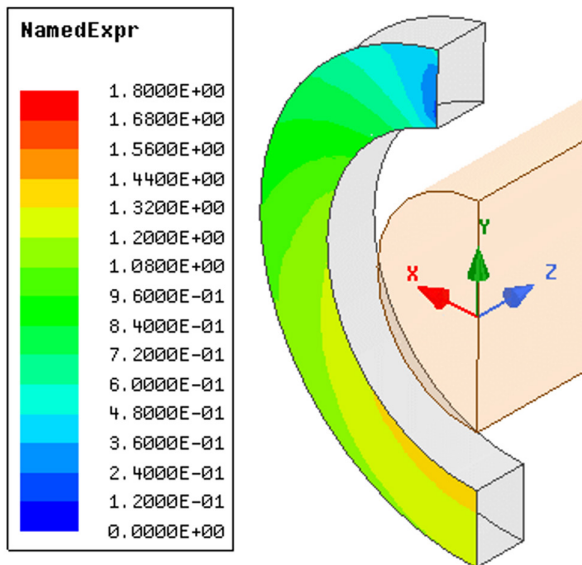

Figure 7: Core magnetization at 600 A DC, in tesla

Now, a sinusoidal current is supplied to the bus bar with a 600 A peak value.

Three cores are evaluated:

- Bulk
- Laminated with 0.375 mm sheets, along the Z direction
- Laminated with 0.250 mm sheets, along the Z direction

Figure 8 reports the magnetic core sensitivity attenuation δ over frequency. The attenuation, in percent, at frequency f is defined as:

$$\delta = \frac{S_{C_f} - S_{C_DC}}{S_{C_DC}}$$

S_{C_f} is the core magnetic sensitivity at frequency f .

S_{C_DC} is the core magnetic sensitivity in DC and 10 A.

In a bulk core, the sensitivity decreases very quickly versus frequency: at 100 Hz, this is already significant ($>5\%$). Otherwise said, a bulk core is only suitable for near DC measurements.

Laminated cores can be used up to a few kHz, depending on required accuracy. As expected, thinner sheets result in better AC performances.

Figure 9 displays the phase shift between input current and the magnetic field measured in the air gap. Figure 9 indicates that the magnetic field measured by the IC is lagging the AC current flowing in the bus bar. In a laminated core, this lag can be up to a few electrical degrees for current frequency above a few kHz. As a direct consequence, an input current step could be measured with a significant delay because of its high harmonic content.

Note that the attenuation and the lag are due to the eddy current physics only. A perfect magnetic field sensor with infinite bandwidth would also see these effects.

The attenuation versus the input current is reported in Figure 10 for a 0.375 mm sheet laminated core. A very interesting phenomenon is visible on this plot. At low frequency, the attenuation is constant over the current, whereas attenuation drops around 300 A at 5 kHz. This can be explained by an early saturation of the core which is induced by the eddy currents. Below 300 A, the attenuation is only due to the eddy current in the concentrator which works in the linear area of Figure 5. At 300 A, the eddy currents locally generate a high magnetic field that saturates the core. Hence, the core magnetic sensitivity is already reduced at 300 A, while the core normally saturates at more than 600 A in DC. This is clearly visible while comparing the core magnetization from Figure 7 and Figure 11. Note that the “noise” visible on the core magnetization mapping of Figure 11 is not real but due to the simulation mesh.

Figure 12 represents the eddy current magnitude density inside a section of a 0.375 mm laminated core at 5 kHz and 600 A.

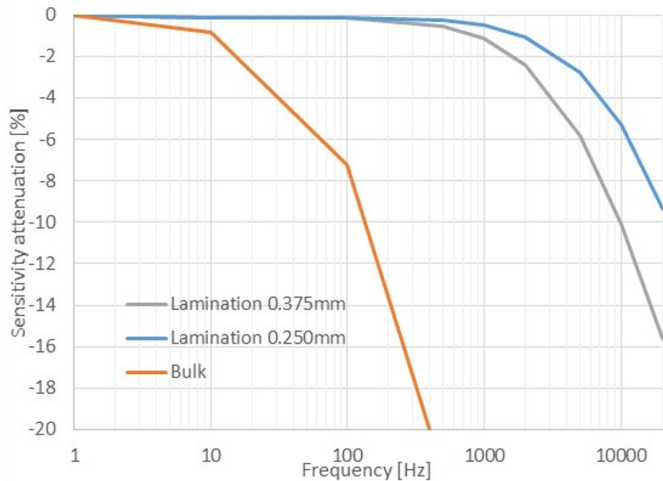

Figure 8: Core sensitivity attenuation vs. frequency at 600 A AC current

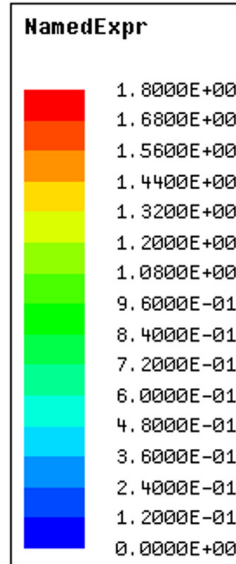

Figure 11: Core magnetization at 600 A, 5 kHz, in tesla, laminated core with 0.375 mm thick sheet

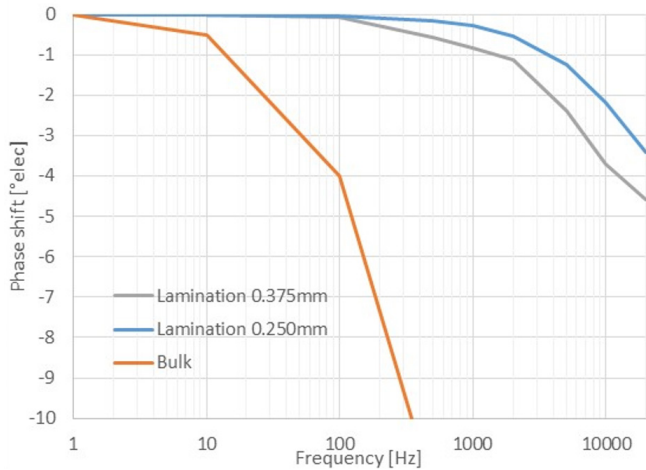

Figure 9: Phase shift vs. frequency at 600 A AC current

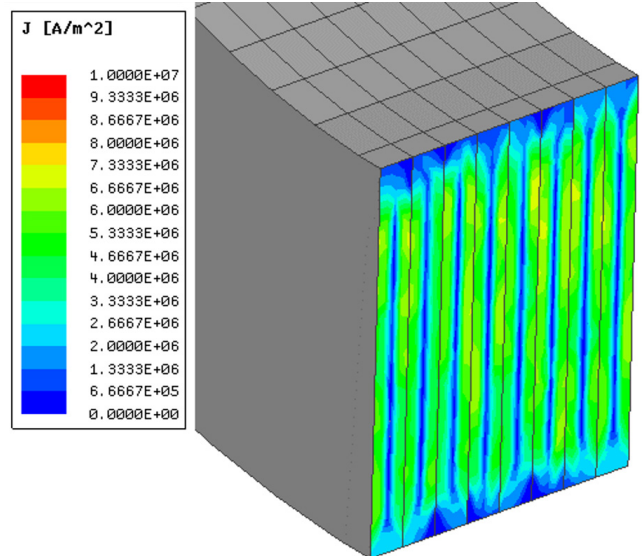

Figure 12: Eddy currents magnitude density inside core with 0.375 mm sheets, at 5 kHz and 600 A, YZ cross section

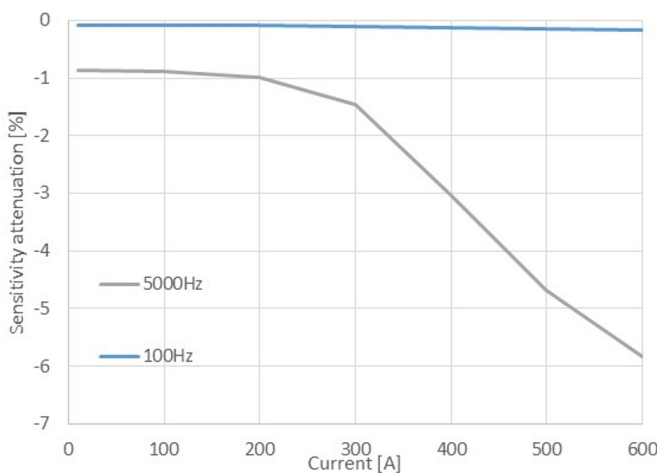

Figure 10: Core sensitivity attenuation vs. current, laminated core with 0.375 mm thick sheet

Conclusions

The analysis shows:

- Eddy currents induce a current measurement error due to an altered core sensitivity and a phase shift between the input current and the generated magnetic field.
- Eddy currents are reduced by core lamination: the thinner the sheets, the better the behavior over frequency.
- Bulk magnetic cores are only for DC measurements or very slow AC, roughly less than 10 Hz.
- Laminated magnetic cores are recommended for AC measurements for frequency up to a few kHz, with sheets of a few hundred μm and a required accuracy around a few percent.
- For a given application, the worst-case measurement error is at maximum application frequency and maximum application current.

Allegro engineers can assist customers to design the best magnetic core for their application depending on current and frequency range. Contact your local Allegro MicroSystems technical center for assistance.

Revision History

Number	Date	Description
-	June 19, 2018	Initial release

Copyright 2019, Allegro MicroSystems.

The information contained in this document does not constitute any representation, warranty, assurance, guaranty, or inducement by Allegro to the customer with respect to the subject matter of this document. The information being provided does not guarantee that a process based on this information will be reliable, or that Allegro has explored all of the possible failure modes. It is the customer's responsibility to do sufficient qualification testing of the final product to insure that it is reliable and meets all design requirements.

Copies of this document are considered uncontrolled documents.

For the latest version of this document, visit our website:

www.allegromicro.com